



## KOLD LOCKER™ WALK-INS



Standard Model Coolers, Freezers and Combination Cooler/Freezers In Stock for SAME DAY SHIPMENT

### STANDARD FEATURES

- **STANDARD MODELS SHIP THE SAME DAY\***
- Coolers, freezers and combination cooler / freezers
- Sizes from 3'6" x 6' to 8' x 20'
- Three heights: 6'7" & 7'7" with floor; 7'4" floorless
- Indoor or outdoor models
- Three temperatures: +35°F., -10°F., -20°F.(-20°F 10 day ship).
- Capsule Pak™ refrigeration system (ceiling or wall mount)
- Air-cooled condensing unit (wall mount 10 day ship)
- Automatic condensate vaporizer. No drain line required on indoor units
- Time clock provided for automatic defrost on both coolers and freezers.
- 26 gauge corrosion resistant stucco embossed temper passed coated steel on all surfaces except interior floor
- Smooth aluminum interior floor (on models with floor)
- Floorless models supplied with NSF listed vinyl sealers
- **Full 4" thick panels foamed-in-place with HFC-134a polyurethane insulation which is CFC and HCFC free**
- 26" wide, self closing door
- Heavy duty adjustable cam-lift hinges
- Spring actuated door closer
- **Deadbolt locking handle with independent key/pad lock feature and inside safety release**
- Magnetic gasket
- Digital thermometer
- Floor double sweep gasket
- Perimeter heater wire
- Vapor-proof light
- Switch and pilot light
- **Registered by UL to ISO 9001:2000**
- NSF, UL flame spread 25 on all panels; UL and CSA electrical listing on door sections
- UL and CSA electrical listing on complete Capsule Pak™ refrigeration systems
- City of New York (MEA) listed
- City of Houston listed
- LA County listed
- California State listed

\*\* Most options are available two weeks from receipt of order. Please contact us for specific questions.

\* Some models ship in 5 or 10 days

### STANDARD FEATURES

- Oregon State listed
- USDA accepted
- **Fifteen year panel warranty**
- 18 month labor warranty
- One year parts warranty

#### INDOOR MODELS:

- Hot gas condensate vaporizer

#### OUTDOOR MODELS:

- White membrane roof and trim
- Refrigeration hood
- Door hood (optional)
- -20°Fahrenheit ambient controls

### OPTIONAL FEATURES\*\*

- U-shaped shelving system
- Floor treadplate kit
- Exterior ramp
- Condensing unit air deflector kit
- Heater kit for cooler located outdoors in below 32°Fahrenheit ambient
- Leak detector / alarm (may be a requirement in some areas)
- Three phase electrical
- Remote Capsule Pak™ refrigeration systems
- Five year compressor warranty
- CEC compliant models available - - additional lead time maybe required
- 220/50/1 electrical
- CE approved models for international installations
- 8'-4" & 8'-7" heights
- Electric vaporizer (for Remote Capsule Pak™ applications)



Nor-Lake, Inc.  
Registered to ISO 9001:2000  
File No. A3204

## WALK-IN SPECIFICATIONS

Kold Locker™ walk-ins are built of modular panels, and are insulated with foamed-in-place HFC-134a polyurethane insulation which is CFC and HCFC free. Each panel is designed to ensure ease of installation, long term reliability and high insulating efficiency.

- A. All panels are manufactured with male and female mating rails to ensure proper alignment during installation. The polyurethane insulation wraps around the return bend metal seams on both section to create a light weight panel of exceptional strength and durability. All panels are a full four (4) inches thick and provide a superior insulating value.
- B. The foamed-in-place cam locking fasteners ensure an airtight seal for maximum energy efficiency.
- C. Kold Locker™ panel gaskets around the outer perimeter of the panel are continuous, without cuts or breaks at corners. The Nor-Lake patented gasket design provides a foamed-in-place gasket as an integral part of the panel. Gaskets cannot fall off or pull off during shipment or installation.
- D. Panels lock together tightly to assure an energy efficient walk-in.
- E. Edge caps for ends of floor and ceiling panels are foamed-in-place rather than overlapped or mechanically fastened. Edge caps cannot come loose, and they stay in place through the life of the walk-in.

- F. Panel Finishes: Interior and exterior complete to be 26 gauge corrosion resistant stucco embossed temper passed coated steel. Models supplied with a floor will include a smooth aluminum interior floor surface.

### Insulation:

Panels to be four (4) inches thick, metal clad and foamed-in-place with HFC-134a polyurethane insulation which is CFC and HCFC free.

### Mini Kold Locker™ Walk-ins 3'6" x 6'0" x 6'7" and 3'6" x 7'0" x 6'7"

Similar floor space as 3 door reach-in. Modular-easy to get into existing building, through doors and hallways. 20%-30% more capacity than 3 door reach-in.

### Expanded Kold Locker™ Coolers:

Now three larger coolers are in stock for Same Day Shipment:

**6' x 14',  
8' x 12',  
8' x 14' Single Compartment**

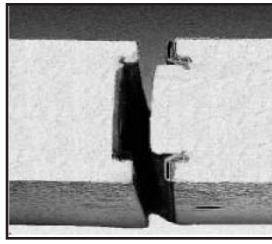

A.

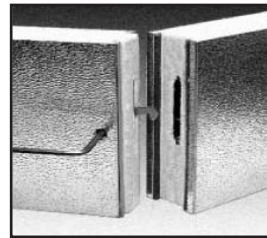

B.

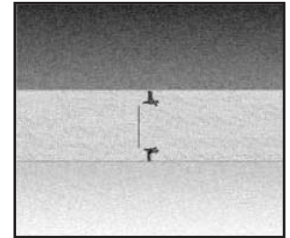

C.

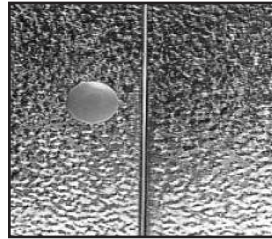

D.

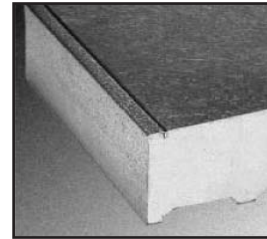

E.

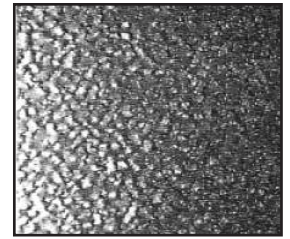

F.

## Kold Locker™ Single Room Coolers or Freezers

### Floor Plan Layouts

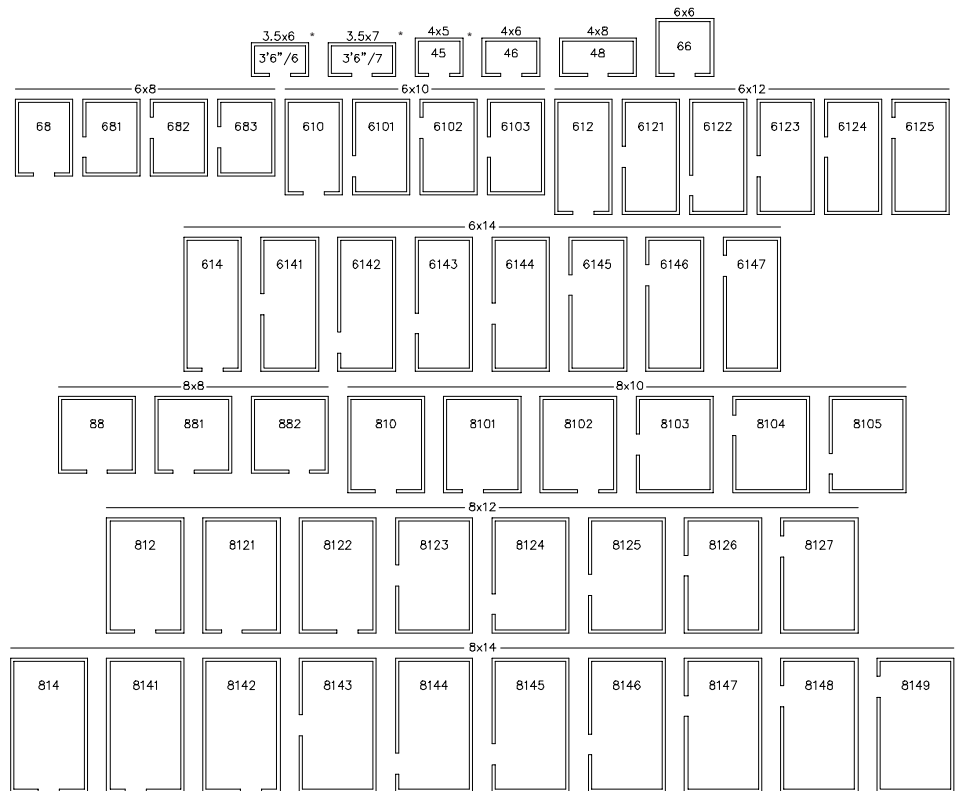

\* 5 Day Ship

## DOOR

Door sections manufactured at Nor-Lake are factory tested to assure proper fit, performance and alignment. All doors feature a stepped profile design that serves as a barrier to air flow which results in an energy efficient door system.

Each Kold Locker™ walk-in compartment is equipped with a 26" wide door. The height of the door opening varies with the series of Kold Locker™ walk-in ordered. The 45 Series has a 59" high door, the Standard Series (6'7" high) has a 66" high door and the 74 and 77 Series Kold Locker™ walk-ins have a 78" high door. The door is self-closing, flush mounted, in-fitting and constructed to incorporate heavy duty, molded ABS breaker which is permanently foamed-in-place.

Doors are available with right or left side hinges and include two cam-lift hinges, top hinge field adjustable with locking set screw, spring actuated door closer, NL 9800 deadbolt locking handle with independent key/padlock feature and inside safety release. The doors are pre-hung in a four foot wide frame panel which is equipped with replaceable perimeter heater wire, magnetic stainless steel trim, digital thermometer, vapor-proof light fixture and switch with exterior pilot indicator light.

The door section is completely pre-wired within concealed conduit inside the door frame panel. 115/60/1 electrical is field wired to a junction box which is surface mounted on the interior frame above the vapor proof light fixture.

Hinges and door handle are mounted to 1/2" synthetic insulated tapping plates. Each door section is complete with a heavy gauge galvanized steel heated threshold.

## FLOOR CONSTRUCTION

Floor panels (when supplied) are similar in construction to the wall panels except they are made to withstand uniformly distributed floor loads of up to 800 pounds per square foot. The interior floor metal is smooth aluminum.

The 74 Series, floorless models, are supplied with a patented vinyl floor sealer to stop conductivity at floor level. This unique sealer sits flat on existing floors and fits tightly against the interior/exterior wall panels. The walk-in wall panel is supported on the shoulder of the sealer so the foam edge is free of compressing weight. The vinyl floor sealer is NSF listed.

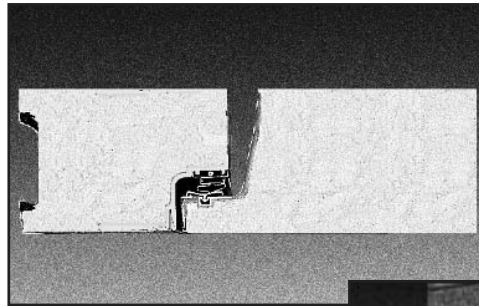

**DOORS FEATURE A STEPPED PROFILE DESIGN**



**VAPOR PROOF LIGHT FIXTURE**



**SPRING ACTUATED DOOR CLOSER**



**DEADBOLT LOCKING HANDLE**

**NL 9800 Deadbolt locking handle with independent key/padlock feature and inside safety release.**

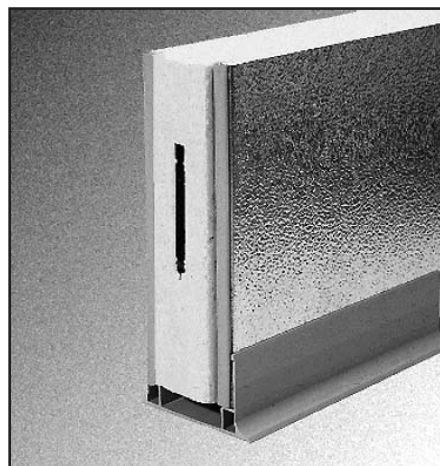

**FLOORLESS MODELS ARE SUPPLIED WITH A PATENTED VINYL FLOOR SEALER**

# PHYSICAL SPECIFICATIONS

## OUTDOOR MODELS:

All Kold Locker™ walk-ins installed outdoors include a weather protection kit consisting of: One piece, 35 mill, white membrane roof material which requires no seaming or gluing to the top of the Kold Locker™ walk-in ceiling panels.

Plastic strips for flashing the membrane roof material to the side of the Kold Locker™ walk-in wall panels are included.

Trim is secured to the Kold-Locker™ wall panels with self drilling and self tapping TEK screws. In applications where the Kold Locker™ walk-in is installed next to a building, the trim can be used to secure the turned up membrane roof material to the building wall, with fasteners supplied by the equipment installer. Above door rain hoods are an option and should be included on installations where the door panels are exposed to the outdoor weather.



## APPROVALS:

Kold Locker™ walk-in construction is approved by the National Sanitation Foundation and shall have the N.S.F. seal on the door section. Walk-in panels shall have a U.L. flame spread rating of 25. The door section is U.L. and C.S.A. listed for electrical safety.

- Registered by UL to ISO 9001
- City of New York (MEA) listed
- City of Houston listed
- LA County listed
- California Sate listed
- Oregon State listed
- USDA accepted
- CECC



Nor-Lake, Inc.  
Registered to ISO 9001:2000  
File No. A3204

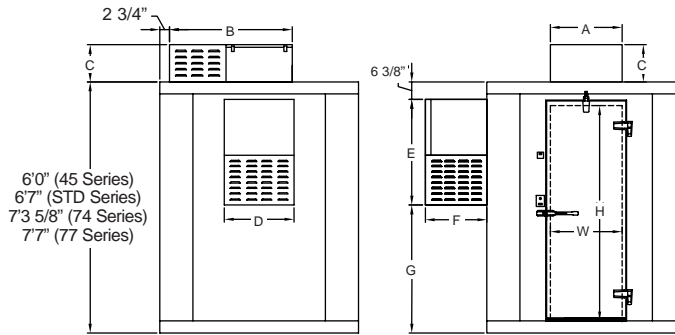

6'0" (45 Series)  
6'7" (STD Series)  
7'3 5/8" (74 Series)  
7'7" (77 Series)

6'7" HIGH	
UNIT	INTERIOR CUBAGE
KL45(6'0" High)	77
KL46	105
KL66	168
KL68	231
KL610	295
KL612	357
KL614	420
KL88	318
KL810	404
KL812	490
KL814	578

7'4" HIGH & 7'7" HIGH	
UNIT	INTERIOR CUBAGE
KL7745	100
KL7746	123
KL7766	196
KL7768	270
KL77610	344
KL77612	418
KL77614	490
KL7788	372
KL77810	473
KL77812	574
KL77814	675

## Door Opening Size

W	H	Model
26"	59"	45 Series
26"	66"	STD Series
26"	78"	74 Series
26"	78"	77 Series

## Corresponding Capsule Pak™ Refrigeration System

Kold Locker Model	38°F-35°F	38°F-35°F	-10°	-10°	-20°	-20°
	Ceiling	Wall	Ceiling	Wall	Ceiling	Wall
KL45	501	050	060	060	N/A	N/A
KL366	501	050	050	060	N/A	N/A
KL367	501	050	050	060	N/A	N/A
KL46	501	050	060	060	100	100
KL66	501	050	075	075	100	100
KL68	050	050	100	100	150	150
KL610	050	050	100	100	150	150
KL612	751	075	150	150	150	150
KL614	100	N/A	N/A	N/A	N/A	N/A
KL88	050	050	100	100	150	150
KL810	751	075	150	150	150	150
KL812	100	N/A	N/A	N/A	N/A	N/A
KL814	100	N/A	N/A	N/A	N/A	N/A
KL7746	501	050	075	075	N/A	N/A
KL7748	050	N/A	100	N/A	N/A	N/A
KL7766	501	050	100	100	150	150
KL7768	050	050	100	100	150	150
KL77610	751	075	150	150	150	150
KL77612	751	075	150	150	151	150
KL77614	100	N/A	N/A	N/A	N/A	N/A
KL7788	751	075	150	150	150	150
KL77810	751	075	150	150	151	150
KL77812	100	N/A	N/A	N/A	N/A	N/A
KL77814	100	N/A	N/A	N/A	N/A	N/A
KL7446	050	050	N/A	N/A	N/A	N/A
KL7466	050	050	N/A	N/A	N/A	N/A
KL7468	751	075	N/A	N/A	N/A	N/A
KL74610	751	075	N/A	N/A	N/A	N/A
KL74612	075	075	N/A	N/A	N/A	N/A
KL74614	100	N/A	N/A	N/A	N/A	N/A
KL7488	075	075	N/A	N/A	N/A	N/A
KL74810	075	075	N/A	N/A	N/A	N/A
KL74812	100	N/A	N/A	N/A	N/A	N/A
KL74814	100	N/A	N/A	N/A	N/A	N/A
KOD45	501	050	060	060	N/A	N/A
KOD46	501	050	075	075	N/A	N/A
KOD66	050	050	100	100	N/A	N/A
KOD68	751	075	100	100	N/A	N/A
KOD610	751	075	150	150	N/A	N/A
KOD612	751	075	150	150	N/A	N/A
KOD614	100	N/A	N/A	N/A	N/A	N/A
KOD88	751	075	150	150	N/A	N/A
KOD810	751	075	150	150	N/A	N/A
KOD812	100	N/A	N/A	N/A	N/A	N/A
KOD814	100	N/A	N/A	N/A	N/A	N/A
KOD7746	751	050	075	075	N/A	N/A
KOD7766	751	075	100	100	N/A	N/A
KOD7768	751	075	150	150	N/A	N/A
KOD77610	751	075	150	150	N/A	N/A
KOD77612	075	075	150	150	N/A	N/A
KOD77614	100	N/A	N/A	N/A	N/A	N/A
KOD7788	075	075	150	150	N/A	N/A
KOD77810	075	075	151	151	N/A	N/A
KOD77812	100	N/A	N/A	N/A	N/A	N/A
KOD77814	100	N/A	N/A	N/A	N/A	N/A

\* Consideration must be given to accessibility for service & free condenser air flow. Consult Factory.  
Subject to change without notice

## KOLD LOCKER™ WALK-IN SIZES AVAILABLE

### SINGLE COMPARTMENT SIZES

**The 45 Series** is available in one size which is 4' wide x 5' long x 6'-0" high. This model is supplied with a walk-in floor. This series ships in 5 days.

**The Standard Series** of Kold Locker™ walk-ins are all 6'-7" high and are all supplied with a floor. The sizes available are as follows: 4' wide x 6' long, 6' wide x 6' long, 6' wide x 8' long, 6' wide x 10' long, 6' wide x 12' long, 8' wide x 8' long, and 8' wide x 10' long.

**The 77 Series** of Kold Locker™ walk-ins are all 7'-7" high and are all supplied with a floor. The sizes available are as follows: 6' wide x 6' long, 6' wide x 8' long, 6' wide x 10' long, 6' wide x 12' long, 8' wide x 8' long, and 8' wide x 10' long.

**The 74 Series** of Kold Locker™ walk-ins are all 7'-3 5/8" high and are all supplied without a floor. Wall panels are installed on top of N.S.F listed vinyl sealers provided. The sizes available are as follows: 6' wide x 6' long, 6' wide x 8' long, 6' wide x 10' long, 6' wide x 12' long, 8' wide x 8' long, and 8' wide x 10' long.

### COMBINATION KOLD LOCKER™ COMPARTMENT SIZES:

The Kold Locker™ combination cooler / freezer line is available in 6'-7" high and 7'-7" high models and are all supplied complete with a floor. All models are available in two widths, 6' wide and 8' wide. The overall length of the combination Kold Locker™ is determined by the size of the cooler compartment and freezer compartment desired. The available sizes are the same as available in their mat-ing single compartment models.

**EXAMPLE #1:** If you have determined that you need a 6' wide combination model your choices for cooler and freezer compartment lengths are 6', 8', 10' and 12'. Therefore, if you desire both cooler and freezer to have lengths of 8' your overall combination dimensions will be 6' wide x 16' long.

**EXAMPLE #2:** If you have determined that you need an 8' wide combination model your choices for cooler and freezer compartment lengths are 6', 8', and 10'. Therefore, if you desire the cooler to be 8' long and the freezer to be 6' long, your overall combination dimensions will be 8' wide x 14' long.



# SHELVING KITS

Shelving kits specifically designed for each Kold Locker™ walk-in configuration are offered as an optional extra. These kits are shipped with the Kold Locker™ walk-in and Capsule Pak™ refrigeration system so that all necessary components are at your location promptly when you need them. The shelving sets are coded to correspond to the Kold Locker™ walk-in configuration ordered and are offered in either three or four tier.

## TWO TYPES OF SHELVING SYSTEMS ARE AVAILABLE FROM NOR-LAKE.

**A. Green Kote™ Shelving** - Green epoxy coated shelves. 15 year guarantee against corrosion.

## B. Nor-Lake Standard Chrome Kote™ Shelving.

Shelving system construction is identical. Select the shelving FINISH of your choice.

Shelving posts are engineered for maximum strength. Shelves are adjustable on 2" centers. All shelves are N.S.F listed and are zinc coated with a heavy layer of Protocoxy for a maximum life span under humid storage conditions. Special clips are utilized to gain the maximum square footage of storage space for each Kold Locker™ model. 14", 18" and 24" wide shelves are used as required for maximum storage capacity in each set. This wire shelving is ideal for storage of all refrigerated or frozen products.

### SHELVES:

Shelves to have #9 (.148") gauge crosswires spaced 3/4" on centers with crossbraces 1/4" (.192") minimum of 4-3/4" on center.

### Shelf Frames

Channel to be 9/16" x 1" x .075" thick.

### Shelf Collars

A round tapered 1-5/16" high steel collar to be welded at each corner.

### FINISHES

**A. Green Kote™:** Electrostatically applied green baked epoxy over zinc steel and brite basic wire.

Thickness : 4-7 mill.

**B. Chrome Kote™:** Plated quality wire and steel. Surface nickel chrome plated.

### POSTS

Posts to be .062" thick 1" O.D. round tubing notched every 2" on each corner of the post.

### POST LEVELERS

Installed on the bottom of each post is nylon housing for a steel leveler 3/8"-16 x 1-3/4".

### FINISHES

**A. Green Kote™:** Electrostatically applied green baked epoxy over zinc steel and brite basic wire.

Thickness : 2-3 mill.

**B. Chrome Kote™:** Plated quality wire and steel. Surface nickel chrome plated.

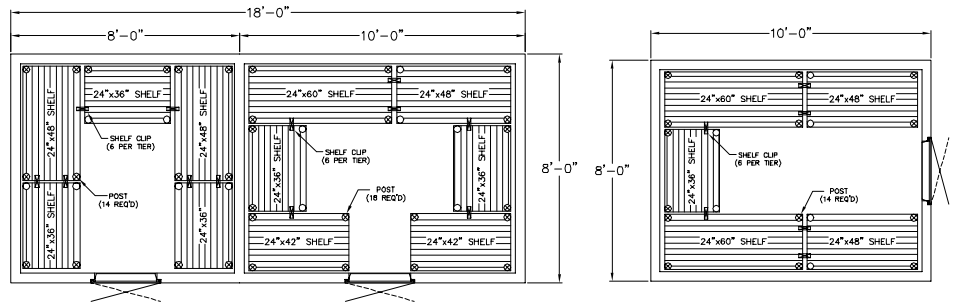
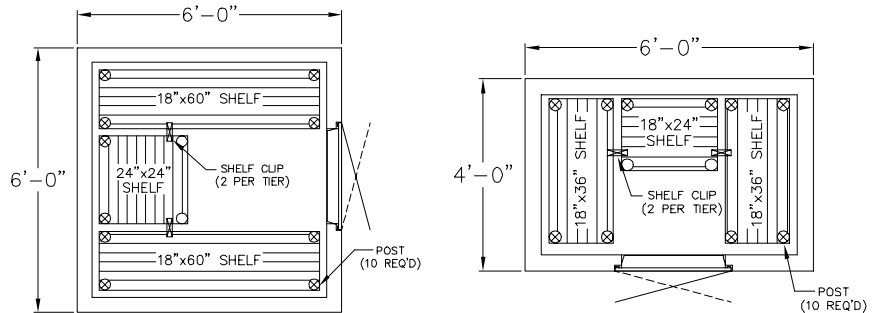

NOR-LAKE, INCORPORATED

727 Second Street

Hudson, Wisconsin 54016

800-955-5253

715-386-2323

800-388-5253 PARTS/SERVICE

715-386-4292 FAX

www.norlake.com

ISO 9001:2000

Registered to ISO 9001:2000

File No. A3204

NORLAKE

© 2006 NOR-LAKE, INC.

Printed in U.S.A.

Part Number: 079297

Revision Date: 2/06

